

# SSL - Horizontal Socket



## Series 9159



The 9159 series of Board-to-Board interconnect system allows two PCB's to be mated end-to-end creating strips of LED lighting. Designed specifically for the unique Solid State Lighting (SSL) market requiring coplanar (horizontal-to-horizontal) PCB mating with a 5 Amp current rating in the smallest package available. These single sided SMT connectors are perfect for both FR4 and metal boards where you need to butt the boards up together to minimize separation. Availability of both white and black insulation colors make them perfect for lighting as well as industrial applications. With sizes from 2p-6p, these high reliability connectors boast gold plated beryllium copper receptacle contacts for harsh environments.

Additional components in the 9159 product family include:

- SSL - Horizontal Plug; Standard 2-Piece solution (10-9159)
- SSL - Cabled Plug; Supports wire-to-board applications (11-9159)
- SSL - Top Load Socket; ZIF style for field reparability (22-9159)
- SSL - Shorting Socket; Two position (58-9159)
- SSL - Retaining Clip; Latches BTB connectors together (80-9159)

### APPLICATIONS

- Coplanar PCB mating in SSL products
- LED linear lighting strips
- Application Notes; refer to 201-01-123

### FEATURES AND BENEFITS

- Single sided SMT; supports FR4 and metal PCB's
- 5 Amp current rating; exceeds general market needs
- 5.5mm mated width; minimizes PCB space to decrease LED pitch
- Gold plated BeCu spring contacts; reliability for harsh environments
- Optional retaining clip; provides positive connector mating during vibration
- Available in white; supports SSL market preferences

### ELECTRICAL

- Current Rating: 5 Amps / Contact
- Voltage Rating: 125 VAC

### ENVIRONMENTAL

- Operating Temperature: -40°C to +125°C

### MECHANICAL

- Insulator Material: Nylon: VL94VO
- Contact Material: BeCu / Phos Bronze
- Plating: Gold / Tin over Nickel
- Durability: 10 Cycles

### HOW TO ORDER

**20**  
Prefix  
Socket

**9159**  
Series

**XXX**  
Number of Ways

Code	No of Ways	Details
002	2	Page 19
003	3	Page 20
004	4	Page 21
005	5	Page 22
006	6	Page 23

**1**  
2 Part  
PCB Strip  
Connector

**01**  
Connector  
Pitch  
01 = 3mm

**X**  
Color Options

Code	Color	Application
0	Black	Industrial
1	White	Lighting

**16**  
Plating Option

Code	Contact	Bracket
16	Gold in Contact Area Gold on Solder Tail	Tin all over

# SSL - Horizontal Socket



Series 9159

## SOCKET 2 WAY 2 PART PCB STRIP CONNECTOR

MARKER IN LINE WITH POSITION I

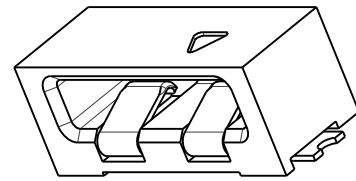
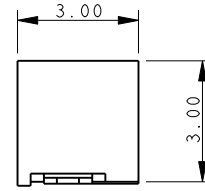
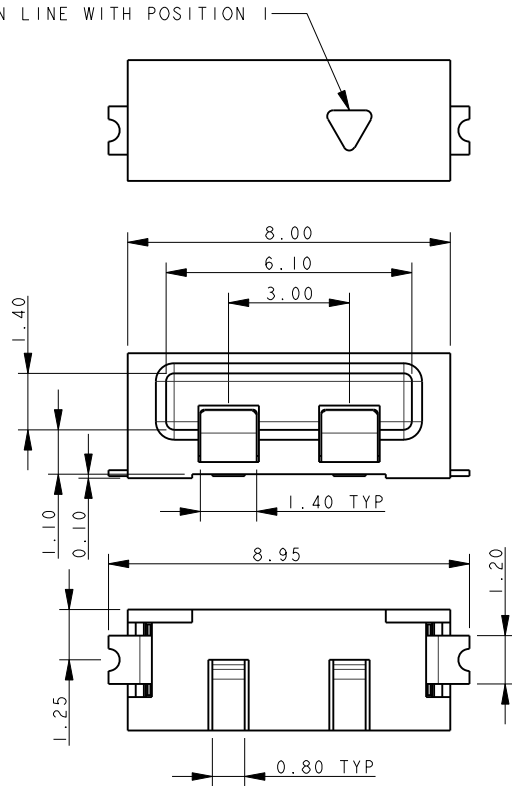

### NOTES:

1. FOR MORE INFORMATION REFER TO PRODUCT SPEC 201-01-119.
2. DIMENSIONS ARE REFERENCE DIMENSIONS UNLESS TOLERANCES.
3. INSULATOR MATERIAL: NYLON 46. COLOR REFER TO PAGE 18.
4. CONTACT MATERIAL: COPPER ALLOY, GOLD OVER NICKEL.
5. BRACKETS: COPPER ALLOY, TIN PLATED.
6. OUTLINE OF CONNECTOR.
7. PACKING TAPE AND REEL, QUANTITY 1400 PER REEL.

## 2 WAY PCB BOARD LAYOUT

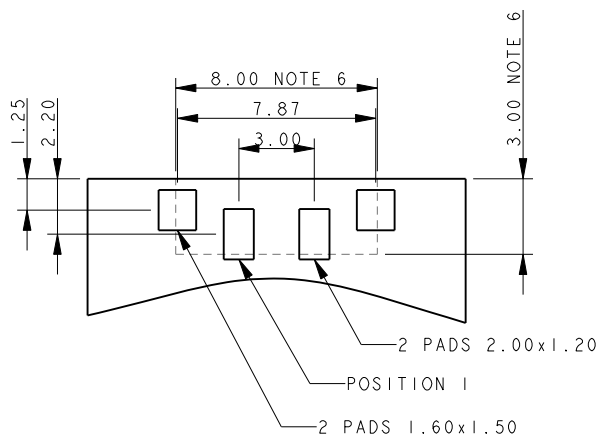

## PACKING DETAILS

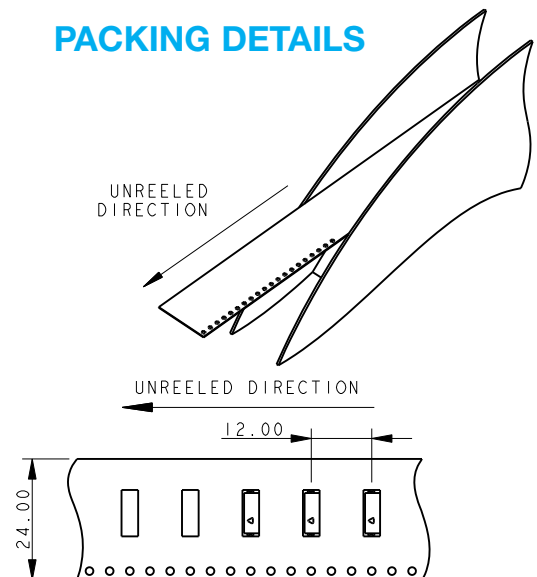

# SSL - Horizontal Socket



Series 9159

## SOCKET 3 WAY 2 PART PCB STRIP CONNECTOR

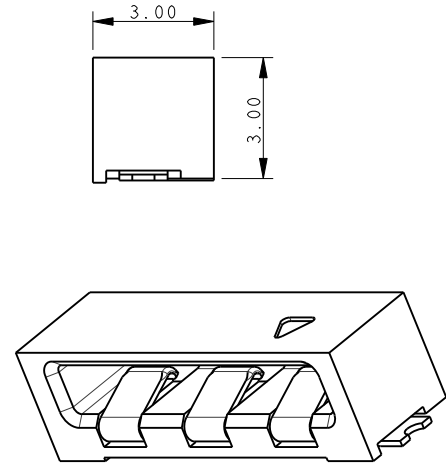
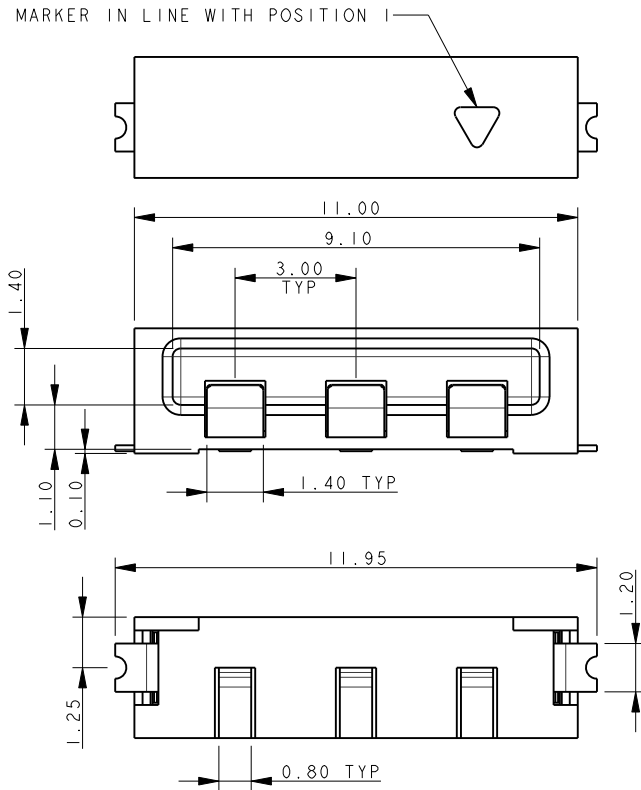

**NOTES:**

1. FOR MORE INFORMATION REFER TO PRODUCT SPEC 201-01-119.
2. DIMENSIONS ARE REFERENCE DIMENSIONS UNLESS TOLERANCES.
3. INSULATOR MATERIAL: NYLON 46. COLOR REFER TO PAGE 18.
4. CONTACT MATERIAL: COPPER ALLOY, GOLD OVER NICKEL.
5. BRACKETS: COPPER ALLOY, TIN PLATED.
6. OUTLINE OF CONNECTOR.
7. PACKING TAPE AND REEL, QUANTITY 1400 PER REEL.

### 3 WAY PCB BOARD LAYOUT

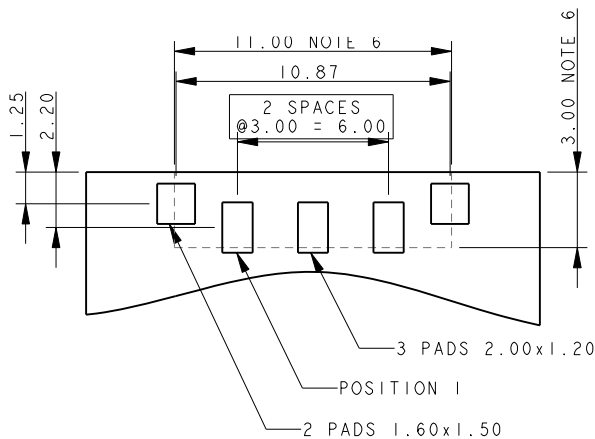

### PACKING DETAILS

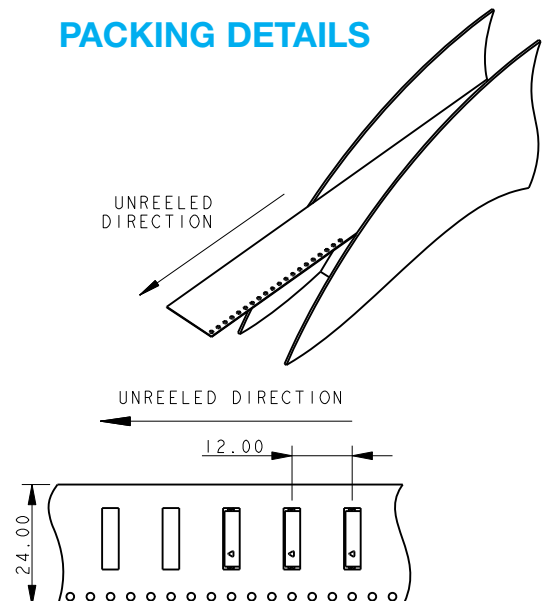

# SSL - Horizontal Socket

Series 9159



## SOCKET 4 WAY 2 PART PCB STRIP CONNECTOR

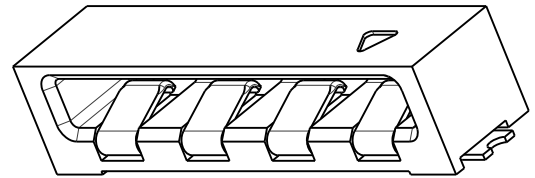
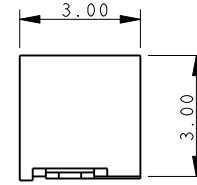
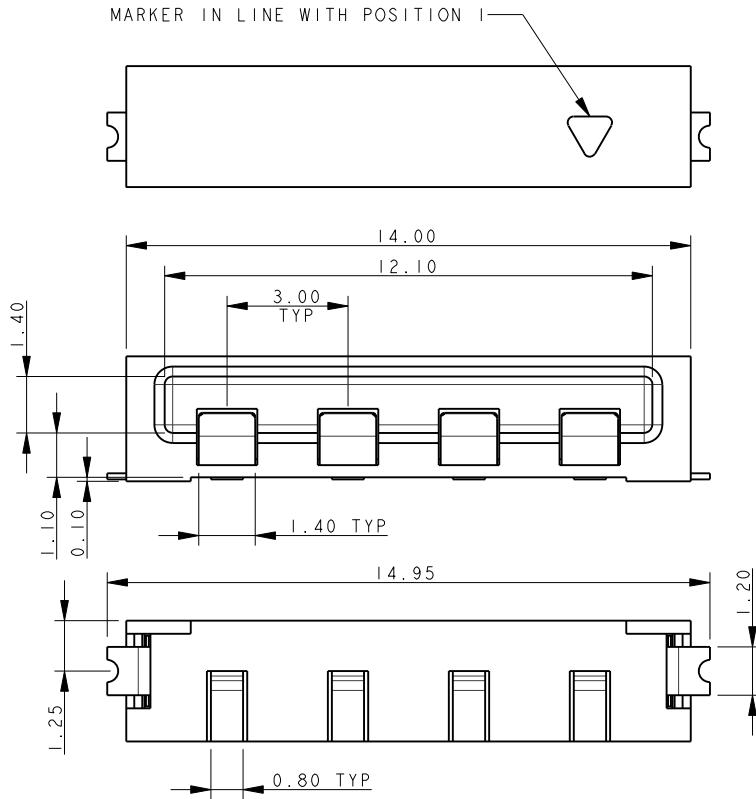

### NOTES:

1. FOR MORE INFORMATION REFER TO PRODUCT SPEC 201-01-119.
2. DIMENSIONS ARE REFERENCE DIMENSIONS UNLESS TOLERANCES.
3. INSULATOR MATERIAL: NYLON 46. COLOR REFER TO PAGE 18.
4. CONTACT MATERIAL: COPPER ALLOY, GOLD OVER NICKEL.
5. BRACKETS: COPPER ALLOY, TIN PLATED.
6. OUTLINE OF CONNECTOR.
7. PACKING TAPE AND REEL, QUANTITY 1400 PER REEL.

## 4 WAY PCB BOARD LAYOUT

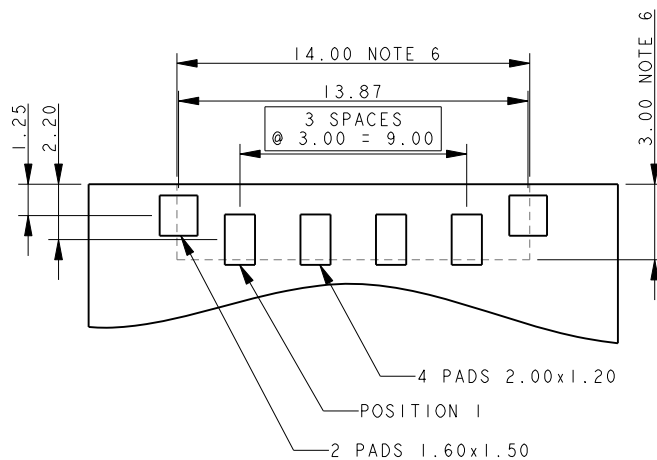

## PACKING DETAILS

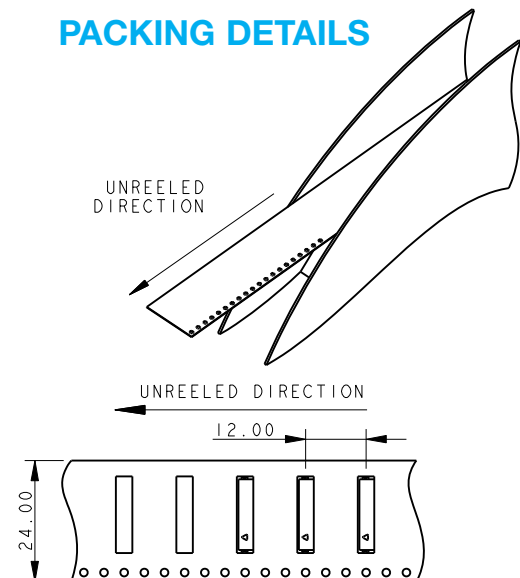

# SSL - Horizontal Socket

Series 9159



## SOCKET 5 WAY 2 PART PCB STRIP CONNECTOR

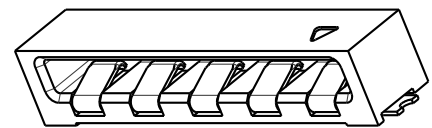
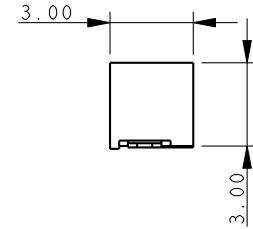
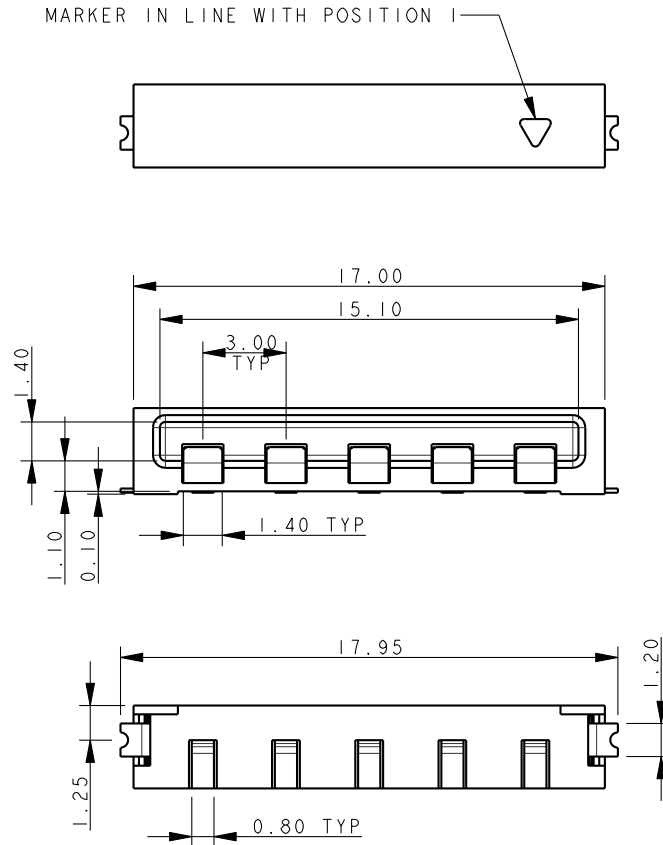

NOTES:

1. FOR MORE INFORMATION REFER TO PRODUCT SPEC 201-01-119.
2. DIMENSIONS ARE REFERENCE DIMENSIONS UNLESS TOLERANCES.
3. INSULATOR MATERIAL: NYLON 46. COLOR REFER TO PAGE 18.
4. CONTACT MATERIAL: COPPER ALLOY, GOLD OVER NICKEL.
5. BRACKETS: COPPER ALLOY, TIN PLATED.
6. OUTLINE OF CONNECTOR.
7. PACKING TAPE AND REEL, QUANTITY 1400 PER REEL.

## 5 WAY PCB BOARD LAYOUT

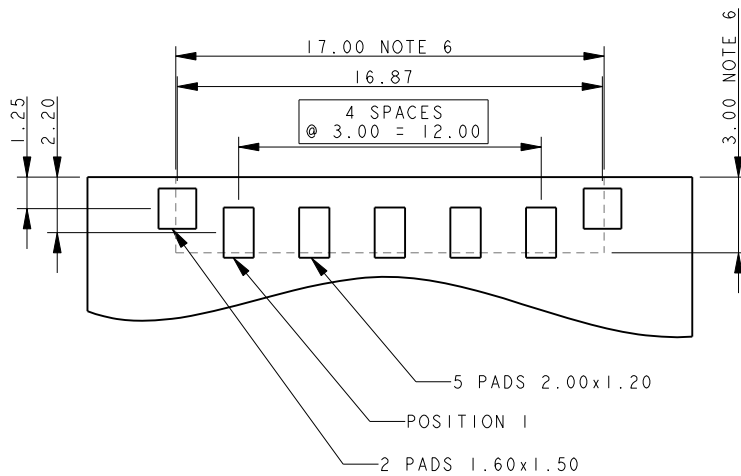

## PACKING DETAILS

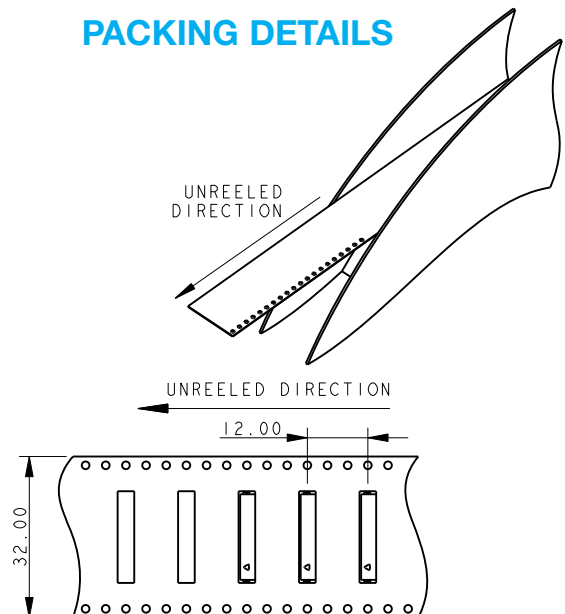

# SSL - Horizontal Socket



Series 9159

## SOCKET 6 WAY 2 PART PCB STRIP CONNECTOR

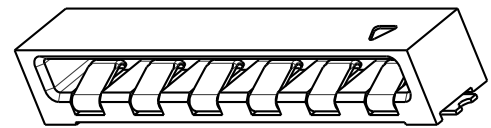
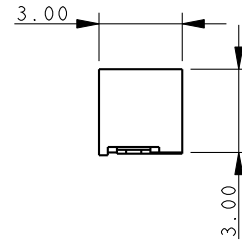
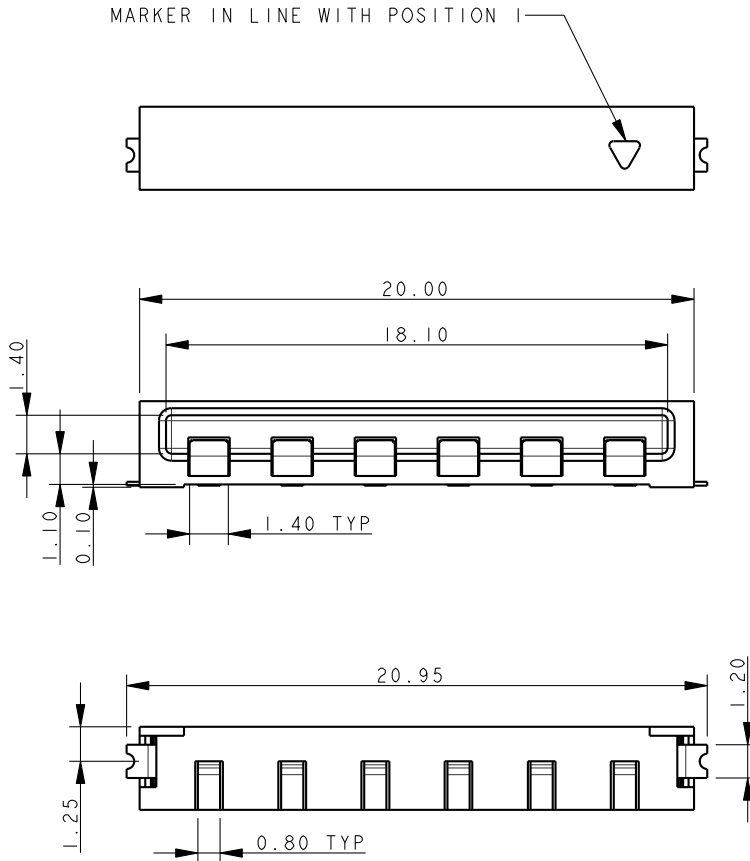

### NOTES:

1. FOR MORE INFORMATION REFER TO PRODUCT SPEC 201-01-119.
2. DIMENSIONS ARE REFERENCE DIMENSIONS UNLESS TOLERANCES.
3. INSULATOR MATERIAL: NYLON 46. COLOR REFER TO PAGE 18.
4. CONTACT MATERIAL: COPPER ALLOY, GOLD OVER NICKEL.
5. BRACKETS: COPPER ALLOY, TIN PLATED.
6. OUTLINE OF CONNECTOR.
7. PACKING TAPE AND REEL, QUANTITY 1400 PER REEL.

## 6 WAY PCB BOARD LAYOUT

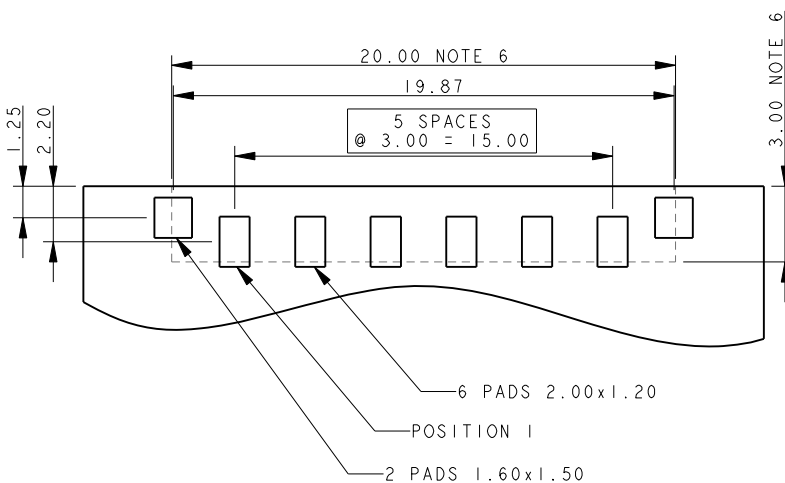

## PACKING DETAILS

